

GENERAL

LOCATION:	Bathroom
CLASS:	CE (Class II)
IP RATING:	IP65
BATHROOM ZONE:	Zone 1, 2, 3
VOLTAGE:	Mains 230V
INSTALLATION ORIENTATION:	Ceiling Mount
MAIN MATERIAL:	Metal - Zinc
DIMENSIONS:	D: 5mm Ø: 83mm
CUT OUT HOLE:	Ø: 70mm/2-3/4"
RECESS DEPTH:	150mm
FIRE RATING:	Not Applicable
CABLE LENGTH:	Not Applicable
GROSS WEIGHT:	0.24Kg

LAMP

LIGHT SOURCE:	LED GU10
MAXIMUM WATTAGE:	6W MAX
LAMP INCLUDED:	No
MAXIMUM LAMP LENGTH:	To Be Advised
R9:	Lamp Dependent
MACADAM ELLIPSE:	Not Applicable
TILT ADJUSTABLE ANGLE:	Not Applicable
ROTATION ADJUSTABLE ANGLE:	Not Applicable
AVERAGE LIFESPAN:	Lamp Dependent
L70:	Not Applicable
BEAM ANGLE:	Lamp Dependent

ELECTRICAL

SWITCHED:	No
DIMMABLE:	Yes
DIMMING METHOD:	Lamp Dependent
DRIVER INCLUDED:	Not Applicable
DRIVER OUTPUT CURRENT:	Not Applicable
DRIVER OUTPUT VOLTAGE:	Not Applicable
SUPPLY FREQUENCY:	Not Applicable
DRIVER/BALLAST VOLTAGE:	Not Applicable
DRIVER AVERAGE LIFESPAN:	Not Applicable
EFFICACY:	Lamp Dependent

ADDITIONAL INFORMATION

SHADE INCLUDED:	Not Applicable
SHADE MATERIAL:	Not Applicable
F MARK:	



CODE: 1236013 (5658)
FINISH: MATT WHITE



CODE: 1236014 (5659)
FINISH: POLISHED CHROME



CODE: 1236015 (5660)
FINISH: BRUSHED NICKEL

TO MAINTAIN THIS PRODUCT TO ITS BEST CONDITION, PLEASE VIEW OUR CARE AND CLEANING GUIDE ON THE SUPPORT SECTION OF THE ASTRO WEBSITE.

Pour entretenir au mieux ce produit, veuillez consulter notre guide d'entretien et de nettoyage, dans la rubrique d'aide sur le site Web d'Astro.

Um dieses Produkt im besten Zustand zu erhalten, beachten Sie bitte unseren Leitfaden zu Pflege und Reinigung im Abschnitt „Support“ auf der Astro-Website.

Per mantenere questo prodotto nelle sue migliori condizioni, consultare la nostra guida per la manutenzione e la pulizia nella sezione dedicata all'assistenza del sito Web Astro.

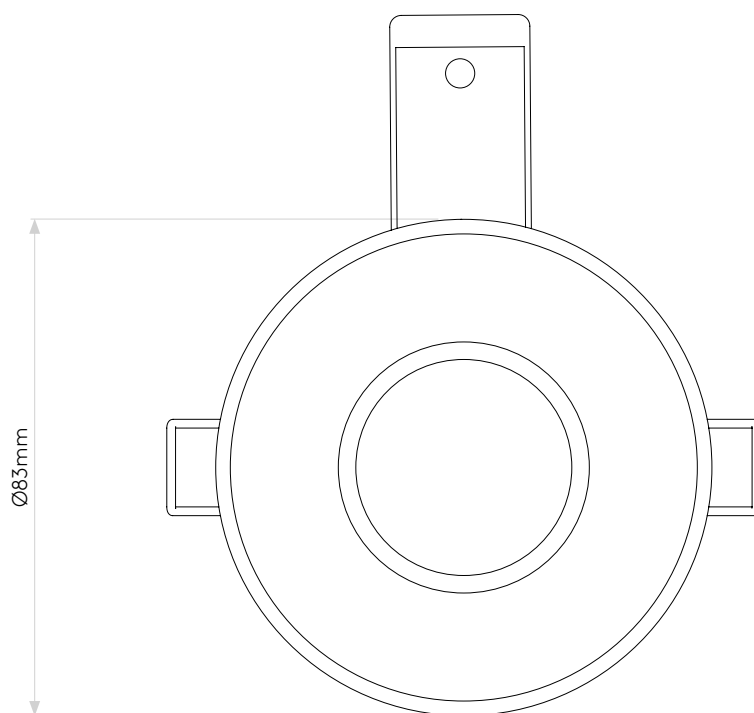
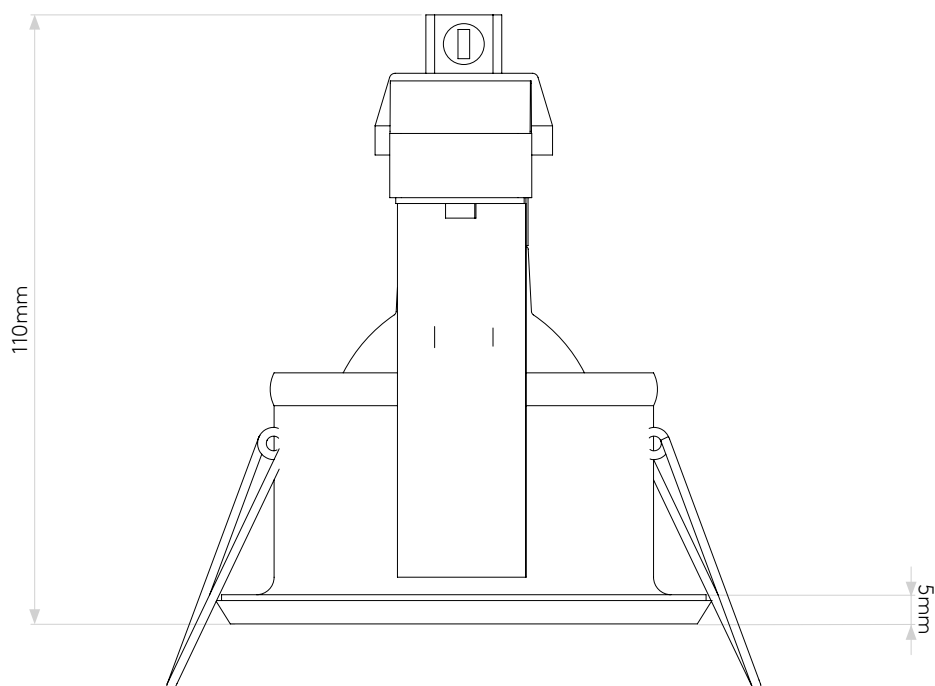

Please note that some dimensions may vary slightly due to manufacturing tolerances, this includes cable entry and fixing holes

Veillez noter que certaines dimensions peuvent varier légèrement en raison des tolérances de fabrication, y compris l'entrée de câble et les trous de fixation.

Bitte beachten Sie, dass die Maße Fertigungstoleranzen unterliegen und daher in geringem Umfang von der angegebenen Größe abweichen können. Dies gilt auch für Kabeleingänge und Befestigungslöcher.

Si prega notare che possono esserci piccole variazioni in alcune dimensioni dovute alle tolleranze di produzione, queste includono l'ingresso del cavo e i fori di fissaggio.