

## GRAFIK Eye® QS Wireless Control Unit (230 V~ CE)

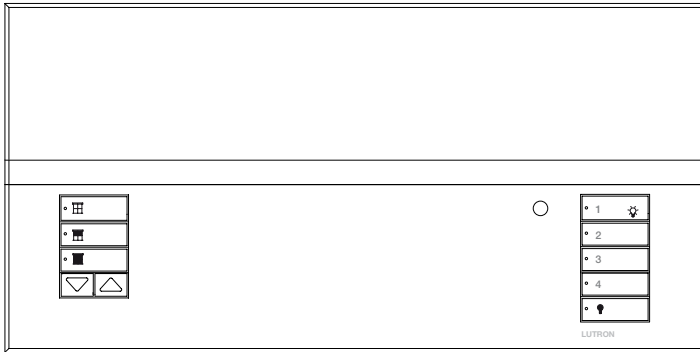

### Description

GRAFIK Eye QS Wireless is the premier energy-saving light and window treatment control. GRAFIK Eye QS includes an astronomic timeclock, intuitive lighting presets, and direct window treatment control. Now with wireless technology, you can use the GRAFIK Eye QS Wireless to seamlessly integrate with a variety of Lutron wireless products and systems, including Radio Powr Savr™ occupancy and vacancy sensors, Sivoia® QS Wireless window treatments, Pico™ wireless control, and other GRAFIK Eye wireless products. Additionally, the GRAFIK Eye QS Wireless is compatible with all Lutron wired QS products and systems.

GRAFIK Eye QS Wireless is compatible with Quantum™.

### System Topologies

The GRAFIK Eye QS Wireless can be specified in three different system topologies:

#### Wired System

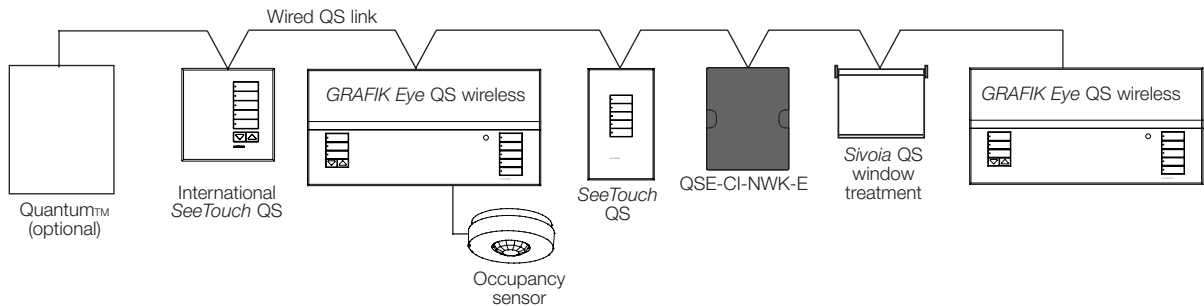

#### GRAFIK Eye-centric Wireless System

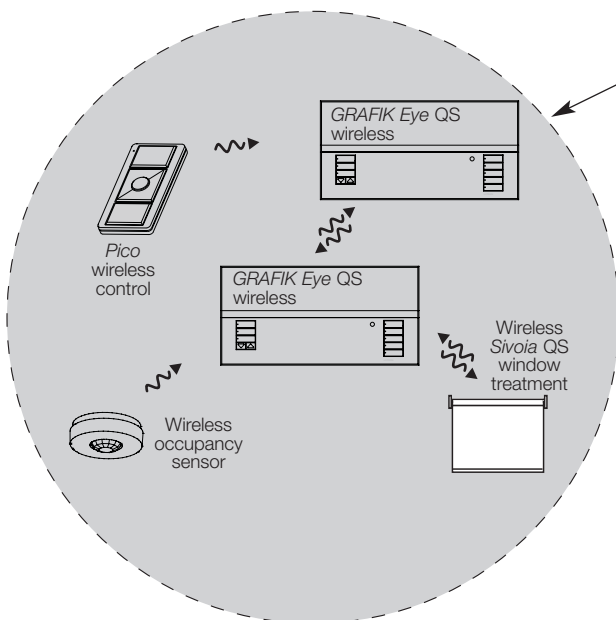

#### Mixed Wired/GRAFIK Eye-centric Wireless System

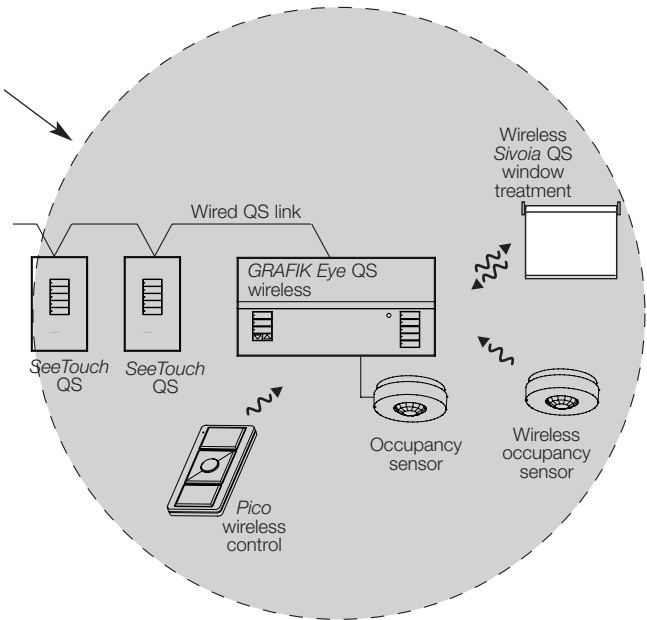

Job Name:	Model Numbers:
Job Number:	

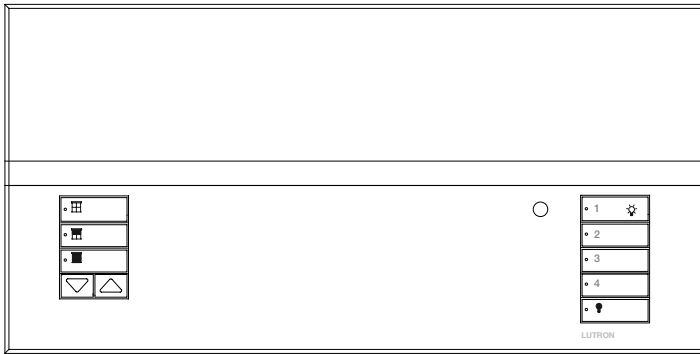

Note: Symbol-based Engraving (-SGN) shown.

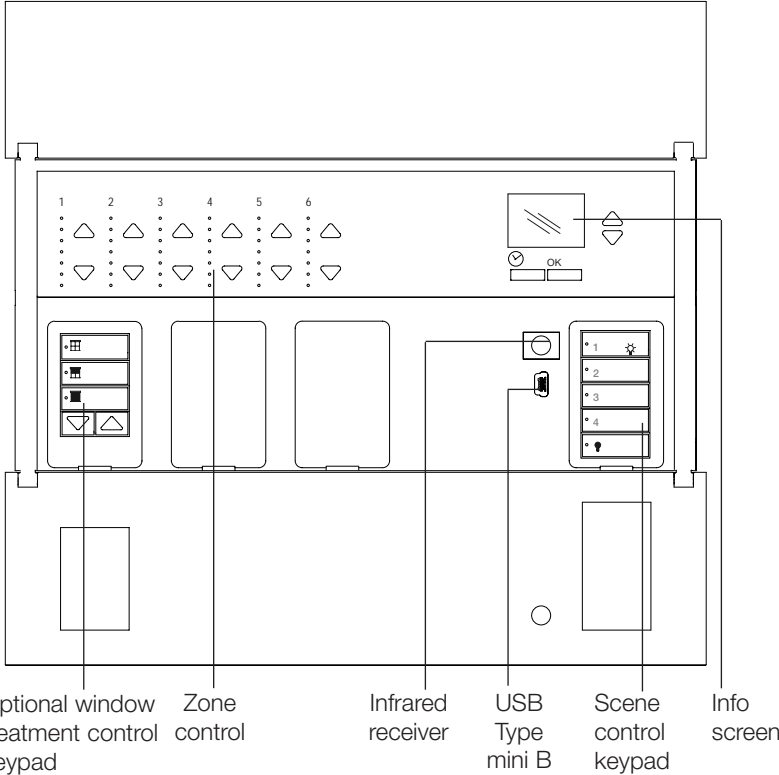

**Features**

- Lutron's proprietary Clear Connect™ RF technology.
- Operates in 868 MHz band.
- Pushbutton recall of four preset lighting scenes, plus Off.
- Twelve (12) additional scenes accessible through other QS devices, such as seeTouch® QS wallstations.
- Optional integrated window treatment control buttons, which can also be added to the unit after installation.
- Master override buttons to raise and lower all lights.
- Allows setup of lighting scenes and window treatment presets using buttons on the control unit.
- Built-in infrared (IR) receiver.
- External IR connection.
- Built-in astronomic timeclock.
- Info screen shows zone light level percentage, energy savings, zone labeling, and programming.
- Lockout option prevents accidental changes.
- One occupancy sensor input and 24 V=== power for occupancy sensor.
- QS communication link for seamless integration of lights, motorised window treatments, wallstations, and integration interfaces.
- Compatible with all Lutron QS system components.
- Wireless communication for seamless integration with a variety of Lutron wireless products and systems, including Radio PowrSavr™ occupancy and vacancy sensors, Sivoia® QS wireless window treatments, PicOTM wireless control, and other GRAFIK Eye QS wireless products.
- Backlit buttons with engraving make unit easy to locate and operate.
- Available in a variety of colours and finishes.

Job Name:	Model Numbers:
Job Number:	

## Specifications

### Input Power

- 230 V~ 50 Hz.

### Lighting Sources/Load Types

Controls the following lighting sources with a smooth, continuous square law dimming curve or on a full conduction non-dim basis:

- Incandescent.
- Halogen.
- Magnetic low-voltage transformer.
- Neon and cold cathode.
- Non-dim (incandescent, magnetic low-voltage, or neon/cold cathode)

Controls the following lighting sources with a smooth, continuous square law dimming curve or on a full conduction non-dim basis through separate power interfaces:

- Electronic low-voltage transformer.
- Non-dim.

### Key Design Features

- RF meets IEC 801-2.
- Lightning strike protection meets ANSI/IEEE standard 62.41-1980. Can withstand voltage surges of up to 6000 V~ and current surges of up to 3000 A.
- Tested to withstand 16 kV electrostatic discharge without damage or memory loss.
- RTISS™-equipped: Compensates in real time for incoming line voltage variations (no visible flicker with +/- 2% change in RMS voltage per cycle, and +/-2% Hz change in frequency per second).
- Power failure memory automatically restores lighting to the scene selected prior to power interruption, and stores timeclock and scene programming.
- Faceplate is hinged at the top and bottom, and stays open at 180° for ease of access.

### Environment

- 32-104 °F (0-40 °C).
- Relative humidity less than 90% non-condensing.

### Listings

- CE.
- Certified for IEC/EN compliance.

### Scene and Window Treatment Buttons

- Large, rounded buttons are easy to use.
- Backlit buttons with optional engraving make it easy to find and to operate the control unit in low light conditions (backlight can be disabled).
- Optional button engraving is angled up to the eye for easy reading.
- Predefined label stickers are included for field labeling.

### Preset Light and Window Treatment Control

- 4 preset lighting scenes, plus Off, are accessible from the front of the control unit.
- 12 additional scenes are stored in the control unit and are accessible from SeeTouch® QS wallstations and QS interfaces.
- Light levels fade smoothly between scenes. Fade time can be set differently for each scene: 0 to 59 seconds, or 1 to 60 minutes. Maximum fade time from Off is 3 seconds.
- Up to 3 columns of window treatment control.
- Open, preset, close, and raise/lower window treatment buttons. Each window treatment column can be programmed to operate one window treatment or a group of window treatments.

### Zone Control

- Each zone has a dedicated raise and lower button to adjust the zone.
- Each zone has a dedicated 7 LED bar graph for level status. Percentage of light level and energy saved is displayed on the info screen.
- All zone information has blue backlit LEDs. Backlight turns off when idle for 30 seconds.

### Info Screen

- OLED screen is viewable from all angles.
- Screen turns off when idle for 30 seconds.
- Programmable zone labels.
- Programmable scene labels.
- Status of real-time zone percentage and energy savings.
- Programmable timeclock schedules.
- Programmable window treatment labels.

<b>Job Name:</b>	<b>Model Numbers:</b>
<b>Job Number:</b>	

## Specifications

### Astronomic Timeclock

- Integral to all units.
- 7 daily schedules available.
- One available holiday schedule is programmable by date up to one year in advance.
- 25 events per day maximum.
- Astronomic times are programmable by integral city database or by entering latitude and longitude. Times automatically adjust throughout the year based on location.
- Automatically adjusts for Daylight Saving Time (DST), adjusted for the new dates; DST is programmable.
- Afterhours feature allows occupants to temporarily override timeclock events.

### System Communications and Capacities

- Low-voltage type PELV (Class 2: USA) wiring connects control units, wallstations, motorised window treatments, and control interfaces.
- A QS system can have up to 100 devices and 100 zones (see System Limits table).
- A QS system can have up to 30 wireless devices.

### Infrared

- Infrared (IR) receiver allows infrared transmitters to select 8 scenes, raise/lower lighting zones, or raise/lower window treatments.
- Transmitter buttons imitate buttons on faceplate.
- 50 ft (15 m) line of sight range.
- Terminal block infrared input for connection to a wired IR input from third-party equipment.
- IR can be disabled via programming.
- Works with Lutron GRX-IT and GRX-8IT infrared remote controls.

### Accessory Controls

- Wired *SeeTouch* QS keypads can be added to the control link.
- Each *GRAFIK Eye* QS can power up to 3 wired *SeeTouch* QS controls.

### Accessory Controls: Pico® Wireless Control (QSR8P)

- The *Pico* Wireless Control is battery powered. It can control *GRAFIK Eye* QS wireless control units within a 30-foot range. It provides the following features:
  - Control of one or more zones on the *GRAFIK Eye* QS Wireless: turns zone(s) on or off, raises/lowers zone(s), and goes to user-defined preset level
  - Scene control: the *Pico* can access scene 1, scene 16, and Off on the *GRAFIK Eye* QS, and can raise and lower lighting levels

### Wireless RF Compatibility

- Lutron's proprietary Clear Connect™ RF Technology
- Operates in the 868 MHz band
- Compatible with other Lutron wireless products, such as:
  - *Pico* (P/N QSR8P-)
  - *Radio Powr Savr* occupancy/vacancy sensors (P/N LRF3-)
  - *Sivoia* QS wireless products
  - Other *GRAFIK Eye* QS wireless units (P/N QSGRK-)

### Occupancy Sensor(s)

- The *GRAFIK Eye* QS works with occupancy sensors through either:
  - Scene Control: Up to four sensors activate user-selectable occupancy and vacancy scenes.
  - Zone Control: up to four sensors per zone activate user-selected occupancy and vacancy zone levels.
- Occupancy sensors may include:
  - Contact closure sensors wired to CCI input on back of *GRAFIK Eye* QS
  - Wireless *Radio Powr Savr*™ occupancy or vacancy sensors (model numbers starting with LRF3)
- If any associated sensor detects occupancy, then the *GRAFIK Eye* QS will go to the designated occupancy level.
- If all associated sensors detect vacancy, then the *GRAFIK Eye* QS will go to the designated vacancy level.

<b>Job Name:</b>	<b>Model Numbers:</b>
<b>Job Number:</b>	

### Contact Closure Input (CCI) with Power Supply Output

- Each *GRAFIK Eye QS* has one contact closure input (Terminal A).
  - The attached device must provide a dry contact closure or solid-state output.
  - Input is miswire-protected up to 36 V $\overline{=}$ .
- Each *GRAFIK Eye QS* can supply 50 mA maximum at 24 V $\overline{=}$ .
  - Useful for powering occupancy sensors.
  - An auxiliary power supply must be used if the device requires more than 50 mA.
- The CCI is capable of operating in the following modes
  - Occupancy: If an occupancy sensor is wired directly to the *GRAFIK Eye QS*.
  - Emergency: This setting allows the *GRAFIK Eye QS* to work with a LUT-ELI. When an emergency situation is detected, all lights will go to full on, and no operations will be allowed until the emergency signal is cleared.
  - Afterhours: Allows the CCI to start and end the afterhours mode.
  - Timeclock: Allows the CCI to enable and disable the timeclock.
  - Scene Lockout: Prevents the user from making any changes to the control unit. The current scene will stay on until the CCI enables normal operation.
  - Save Never: Prevents any changes from being saved while the CCI is being used.
  - Disable CCI: The CCI will have no effect on the system and will not appear on the list of available sensors.

<b>Job Name:</b>	<b>Model Numbers:</b>
<b>Job Number:</b>	

## Specifications















Capacities		
Zones	Unit Capacity (watts)	Zone Capacity (watts)
3	1500	500
4	2000	500
6	2300	500

### Load Type Notes

- For applications with load wattages exceeding the specified capacities, please refer to specifications for Lutron power modules (NGRX-PB-CE; ELVI-1000-CE).
- Not all loads must be connected; however, connected zones must have a minimum load of 40 W.
- Maximum total lighting load for a magnetic low-voltage zone is 500 VA / 400 W.
- No zone may be loaded with more than 500 W.

### System Limits

- The QS wired communication link is limited to 100 devices (wired or wireless) or 100 zones. Please note the zone count and power draw unit information in the following table.

QS Device	Zone Count	Power Draw Units (supplied)	Power Draw Units (consumed)
 3-zone <i>GRAFIK Eye</i> QS	3	3	0
 4-zone <i>GRAFIK Eye</i> QS	4	3	0
 6-zone <i>GRAFIK Eye</i> QS	6	3	0
 6-zone <i>GRAFIK Eye</i> QS	6	3	0
 8-zone <i>GRAFIK Eye</i> QS	8	3	0
 16-zone <i>GRAFIK Eye</i> QS	16	3	0
 <i>seeTouch</i> QS	0	0	1
 International <i>seeTouch</i> QS	0	0	1
 <i>Sivoia</i> QS	1	0	(Refer to Spec. Submittal)
 Contact closure interface	2	0	3
 Network interface	0	0	2
 DMX interface	0	0	2
 QS smart power panel	0	(Refer to Spec. Submittal)	0
 QS link power supply	0	8	0

<b>Job Name:</b>	<b>Model Numbers:</b>
<b>Job Number:</b>	

### Mechanical Dimensions

Fits into a 4-gang U.S. backbox, 3.5 in. (89 mm) deep;  
Lutron P/N 241-400

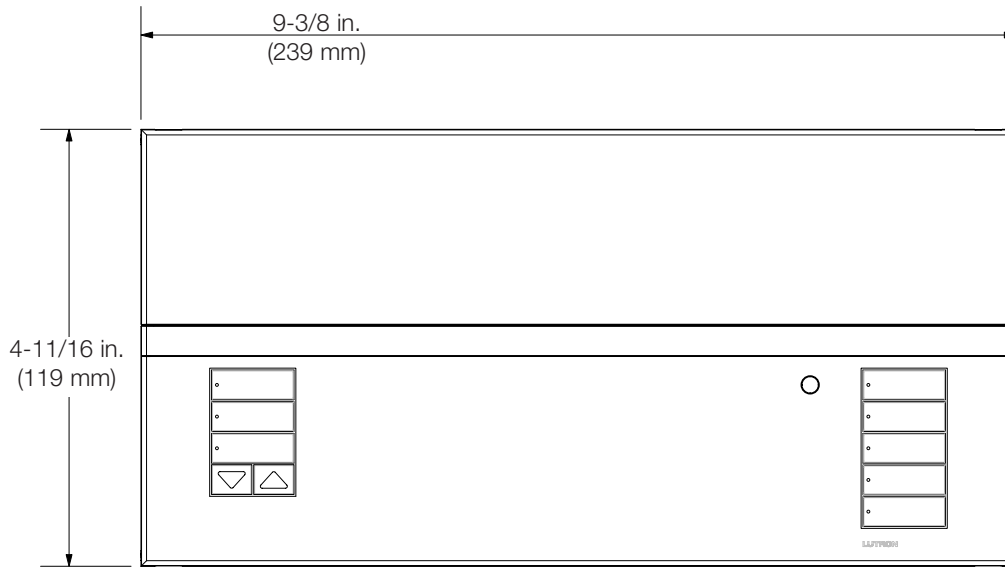

Front View

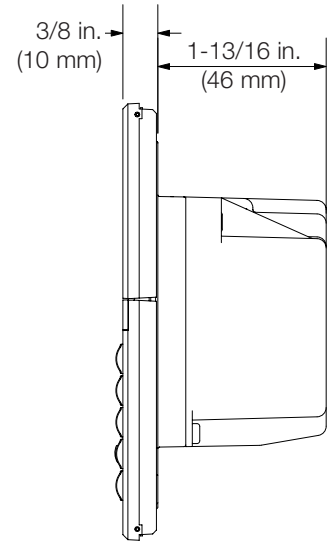

Side View

Job Name:	Model Numbers:
Job Number:	

## GRAFIK Eye QS Wireless Standard Model Numbers

See following pages for Ordering Custom (Non-Standard) Model Numbers

See Standard Colour Combinations page for faceplate, stripe, and button colours

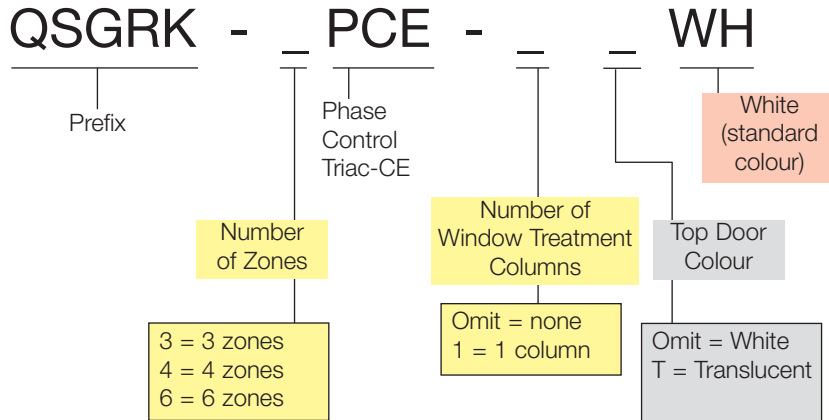

Example:

**QSGRK-6PCE-1TWH**

6-zone standard white unit with 1 window treatment column and translucent top door.

Unit will ship unengraved with engraving certificate that customer can redeem at no charge.

### Available Standard Model Numbers

3 Zones

QSGRK-3PCE-WH  
QSGRK-3PCE-TWH  
QSGRK-3PCE-1WH  
QSGRK-3PCE-1TWH

4 Zones

QSGRK-4PCE-WH  
QSGRK-4PCE-TWH  
QSGRK-4PCE-1WH  
QSGRK-4PCE-1TWH

6 Zones

QSGRK-6PCE-WH  
QSGRK-6PCE-TWH  
QSGRK-6PCE-1WH  
QSGRK-6PCE-1TWH

### Important Note:

For any non-standard units, you must order **BOTH** a base unit and a Faceplate Kit. Please see the Custom Ordering Information on the following pages.

Job Name:	Model Numbers:
Job Number:	



## GRAFIK Eye® QS Wireless

### Custom Colour Options and Model Numbers

You must order a Base Unit and a Faceplate Kit

See Standard Colour Combinations page for faceplate, stripe, and button colours

#### Base Unit

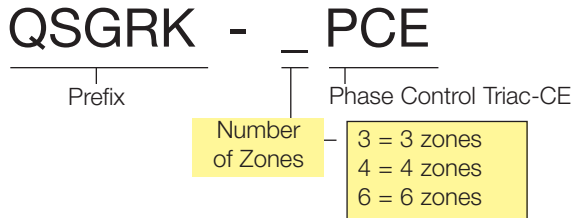

#### Example:

**QSGRK-6PCE**

6-zone base unit  
and

**QSGFP-2IV-SGN**

Ivory faceplate kit with two window treatment columns and symbol-based engraving

#### Faceplate Kit

(includes coordinating stripe and buttons; see Standard Colour Combinations page)

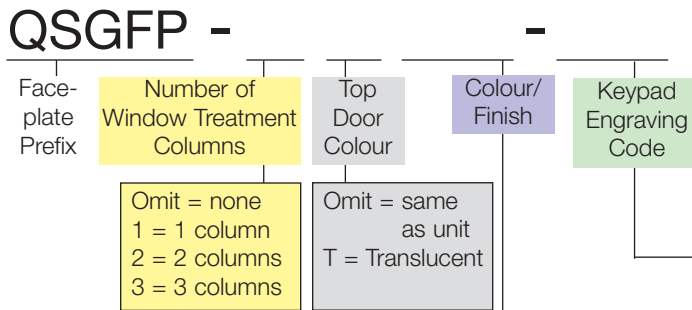

Faceplate Custom Colour/Finish Codes					
<b>Architectural Matte Finishes</b>		<b>Architectural Metal Finishes</b>		<b>Satin Colour Matte Finishes</b>	
Standard		Bright Brass	BB	Snow	SW
(ship in 48 hours)		Bright Chrome	BC	Biscuit	BI
White	WH	Bright Nickel	BN	Eggshell	ES
Ivory	IV	Satin Brass	SB	Taupe	TP
Beige	BE	Satin Chrome	SC	Midnight	MN
Gray	GR	Satin Nickel	SN	Limestone	LS
Brown	BR	Antique Brass	QB	Stone	ST
Black	BL	Antique Bronze	QZ	Desert Stone	DS
Almond	AL			Terracotta	TC
Light Almond	LA			Hot	HT
		<b>Anodised Aluminum Finishes</b>		Goldstone	GS
		Clear	CLA	Palladium	PD
		Black	BLA	Plum	PL
		Brass	BRA	Turquoise	TQ
<b>International Wallbox Finishes</b>				Bluestone	BG
Argentum	AR			Sea Glass	SG
Mica	MC			Greenbrier	GB
Arctic White	AW			Sienna	SI
				Merlot	MR
				Mocha Stone	MS

#### Keypad Engraving Codes

Omit = Unengraved  
Ships with engraving certificate that customer can redeem at no charge  
SGN = Symbol-based Engraving

• 1	•
• 2	•
• 3	•
• 4	•
•	•

Lighting keypad | Window treatment column

NST = Non-Standard Text Engraving  
Please visit the *GRAFIK Eye QS* website at [www.lutron.com/grafikyeqs](http://www.lutron.com/grafikyeqs) for custom engraving forms. Submit completed form with order, and unit will ship engraved as specified by customer.

<b>Job Name:</b>	<b>Model Numbers:</b>
<b>Job Number:</b>	

## GRAFIK Eye® QS Wireless

### Custom Options and Model Numbers

See previous pages for Standard and Other Custom Model Numbers

See Standard Colour Combinations page for faceplate, stripe, and button colours

### Custom Button Kit

# QSGB - 5B - WH -

Custom Button Kit Prefix

Button Configuration

Button Colour/Finish

Keypad Engraving Code

3BRL = 3-button with raise/lower (window treatment column)  
5B = 5-button (lighting keypad)

#### Button Kit Custom Colour/Finish Codes

##### Architectural Matte Finishes

White	WH
Ivory	IV
Beige	BE
Gray	GR
Brown	BR
Black	BL
Almond	AL
Light Almond	LA

##### Satin Colour Matte Finishes

Snow	SW
Biscuit	BI
Eggshell	ES
Taupe	TP

#### Keypad Engraving Codes

Omit = Unengraved  
Ships with engraving certificate that customer can redeem at no charge

SGN = Symbol-based Engraving



Lighting keypad

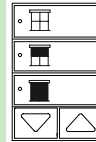

Window treatment column

NST = Non-Standard Text Engraving  
Please visit the *GRAFIK Eye QS* website at [www.lutron.com/grafikeyeqs](http://www.lutron.com/grafikeyeqs) for custom engraving forms. Submit completed form with order, and unit will ship engraved as specified by customer.

### Custom Stripe Kit

# QSGS - WH

Stripe Kit Prefix

Stripe Colour/Finish

#### Stripe Custom Colour/Finish Codes

Same as Faceplate colours on previous page

Job Name:	Model Numbers:
Job Number:	

## GRAFIK Eye QS Wireless Standard Colour Combinations

### See previous pages for Standard and Custom Model Numbers

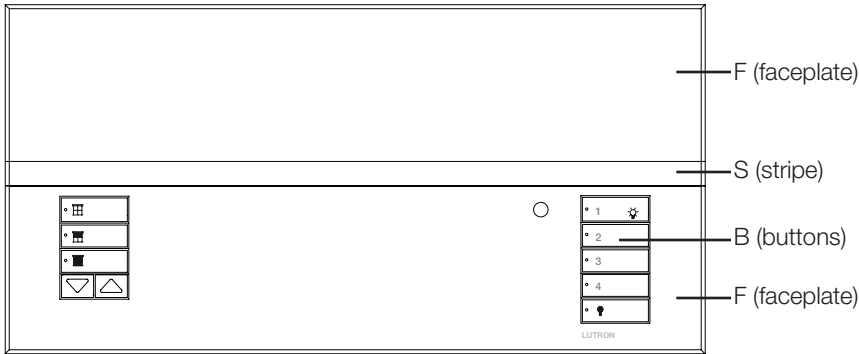

Faceplate is comprised of a top and bottom. The bottom will always be the colour indicated under "faceplate." The top may be the same colour or translucent. Use the chart for faceplates that have the same colour top and bottom. If a translucent lid is chosen, the stripe will automatically be the same colour as the bottom lid.

Example:

If you order QSGRK-4PCE-1WH, your GRAFIK Eye QS with 4 lighting zones and 1 window treatment column will come with a white faceplate (both top and bottom), gray stripe, and white buttons.

Suffix	Faceplate (F)	Stripe (S)	Button (B)	Suffix	Faceplate (F)	Stripe (S)	Button (B)
<b>Architectural Matte</b>				<b>Satin Matte</b>			
WH	White	Gray	White	MN	Midnight	Gray	Black
IV	Ivory	Beige	Ivory	TP	Taupe	Gray	Taupe
BE	Beige	Ivory	Beige	SW	Snow	Gray	Snow
GR	Gray	Black	Gray	ES	Eggshell	Beige	Eggshell
BR	Brown	Black	Brown	BI	Biscuit	Eggshell	Biscuit
BL	Black	Gray	Black	LS	Limestone	Gray	Gray
AL	Almond	Light Almond	Almond	ST	Stone	Gray	Gray
LA	Light Almond	Almond	Light Almond	DS	Desert Stone	Taupe	Taupe
<b>Architectural Metal</b>				TC	Terracotta	Taupe	Taupe
BB	Bright Brass	Black	Black	BG	Bluestone	Gray	Gray
BC	Bright Chrome	Black	Black	HT	Hot	Taupe	Taupe
BN	Bright Nickel	Black	Black	MR	Merlot	Taupe	Taupe
SB	Satin Brass	Black	Black	SI	Sienna	Brown	Brown
SC	Satin Chrome	Black	Black	GB	Greenbrier	Gray	Gray
SN	Satin Nickel	Black	Black	SG	Sea Glass	Gray	Gray
QB	Antique Brass	Black	Black	MS	Mocha Stone	Taupe	Taupe
QZ	Antique Bronze	Black	Black	GS	Goldstone	Ivory	Ivory
<b>Anodised</b>				PD	Palladium	Gray	Gray
CLA	Clear	Black	Black	PL	Plum	Taupe	Taupe
BLA	Black	Black	Black	TQ	Turquoise	Gray	Gray
BRA	Brass	Black	Black				
<b>International Wallbox</b>							
AR	Argentum	Black	Black				
MC	Mica	Gray	Black				
AW	Arctic White	Gray	White				

<b>Job Name:</b>	<b>Model Numbers:</b>
<b>Job Number:</b>	

## Wiring Diagrams

### Terminations

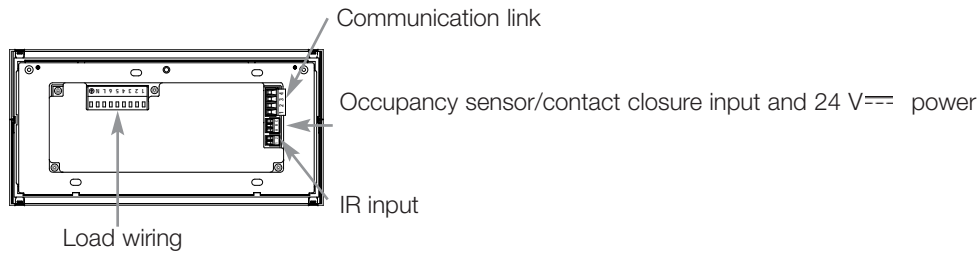

## PELV (Class 2: USA) QS System Low-Voltage Terminal Connections

- Each PELV (Class 2: USA) terminal accepts up to two 18 AWG (1.0 mm<sup>2</sup>) wires.
- Connect the terminal 1, 3, and 4 connections to all control units, wallstations, and control interfaces.
- Each control unit has its own power supply. Terminate the terminal 2 connection (24 V<sub>DC</sub> power) so that each control unit supplies power to a maximum of three wallstations. Each wallstation should receive power from only one control unit.
- Total length of control link must not exceed 610 m (2,000 ft).
- Do not allow PELV (Class 2: USA) wires to contact line/mains wires.

Control units shown in rear view

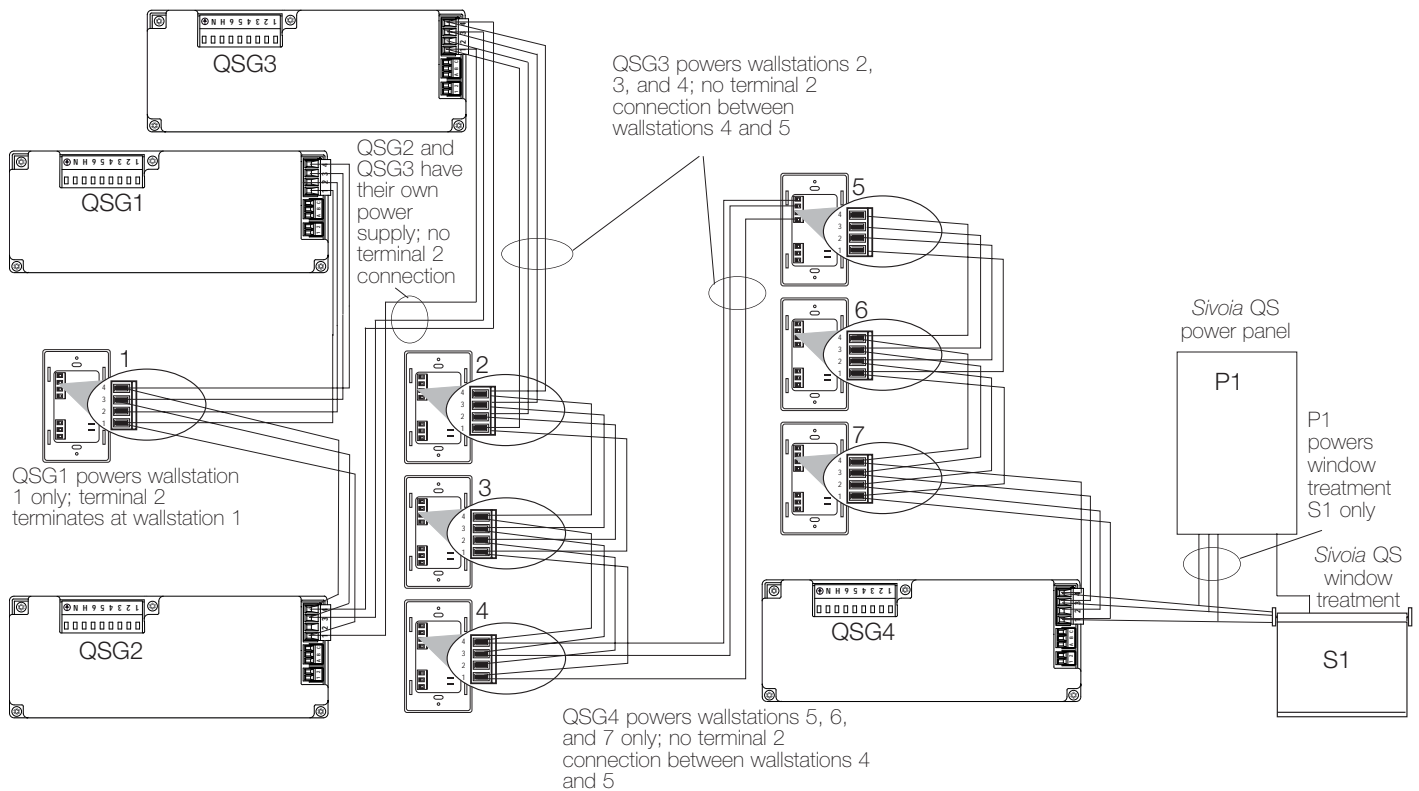

<b>Job Name:</b>	<b>Model Numbers:</b>
<b>Job Number:</b>	

## Mounting

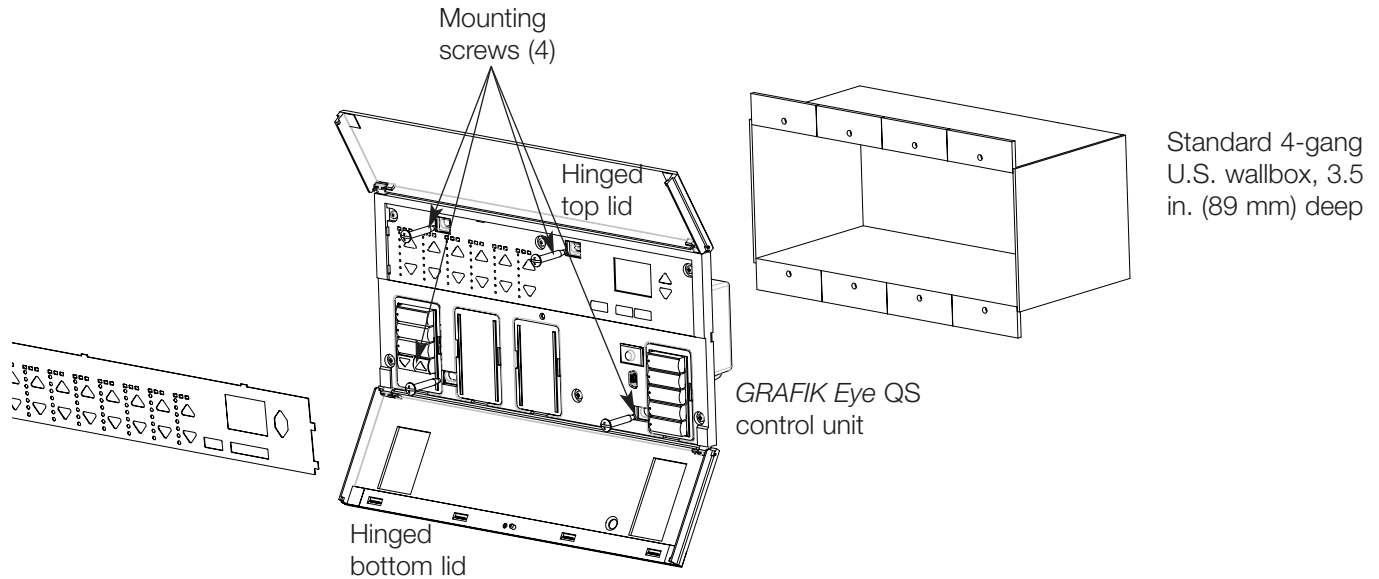

## Line Voltage Wiring

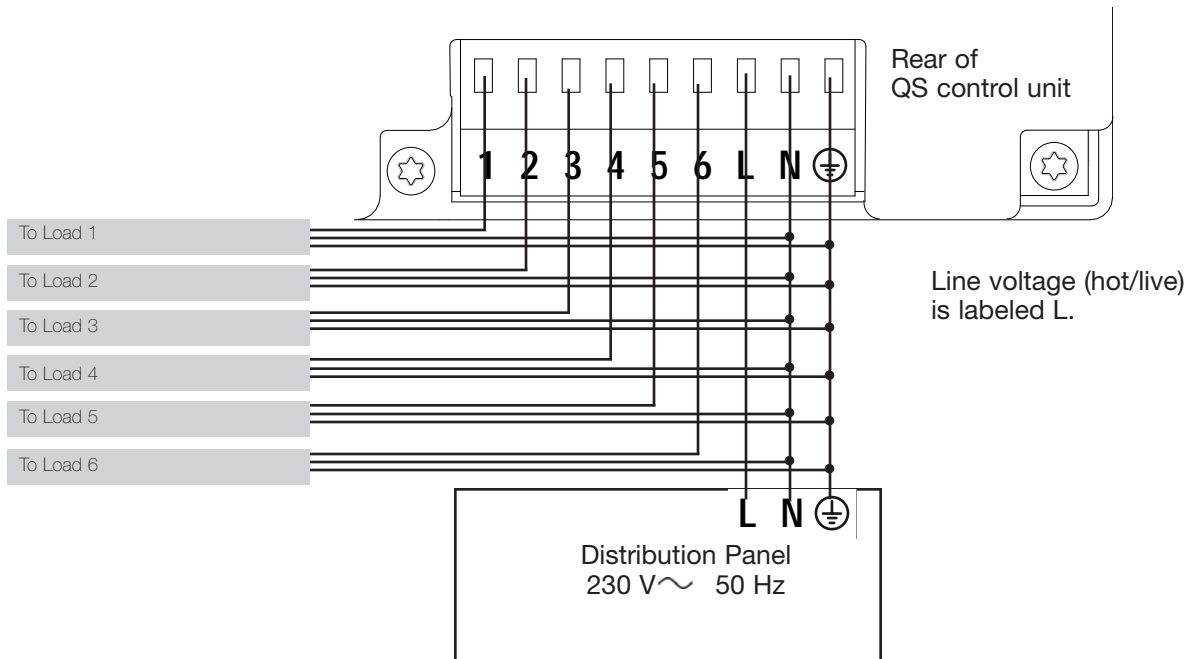

- Pull power wiring from distribution panel and to light fixtures.
- Each line voltage terminal can accept one 12 AWG (2.5 mm<sup>2</sup>) wire.
- Consult Lutron for non-dim relay wiring and/or load side emergency transfer wiring.

Job Name:	Model Numbers:
Job Number:	

## PELV (Class 2: USA) QS System Low-Voltage Wiring

- System communication uses low-voltage wiring.
- Wiring can be daisy-chained or T-tapped.
- Wiring must be run separately from line/mains voltage.
- PELV (Class 2: USA) wiring link requires:
  - Two 18 AWG (1.0 mm<sup>2</sup>) conductors for control power.
  - One twisted, shielded pair of 22 AWG (0.5 mm<sup>2</sup>) for data link.
  - Available from Lutron, P/N GRX-CBL-346S; check compatibility in your area.
- Total length of control link must not exceed 610 m (2,000 ft).

### Daisy-Chain Wiring Example

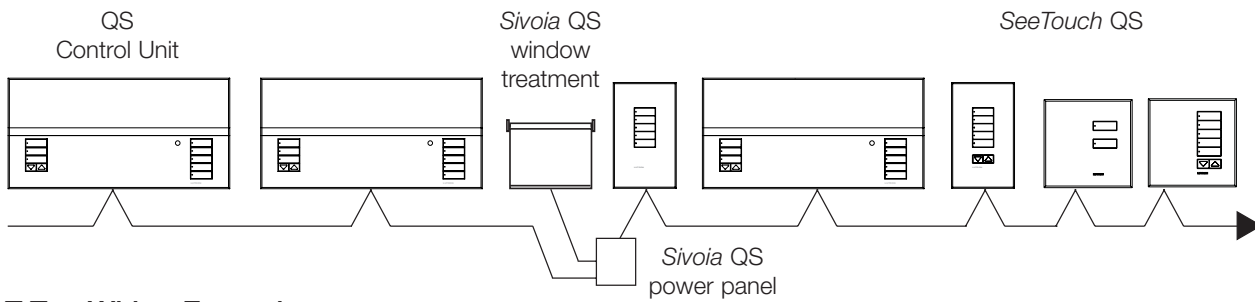

### T-Tap Wiring Example

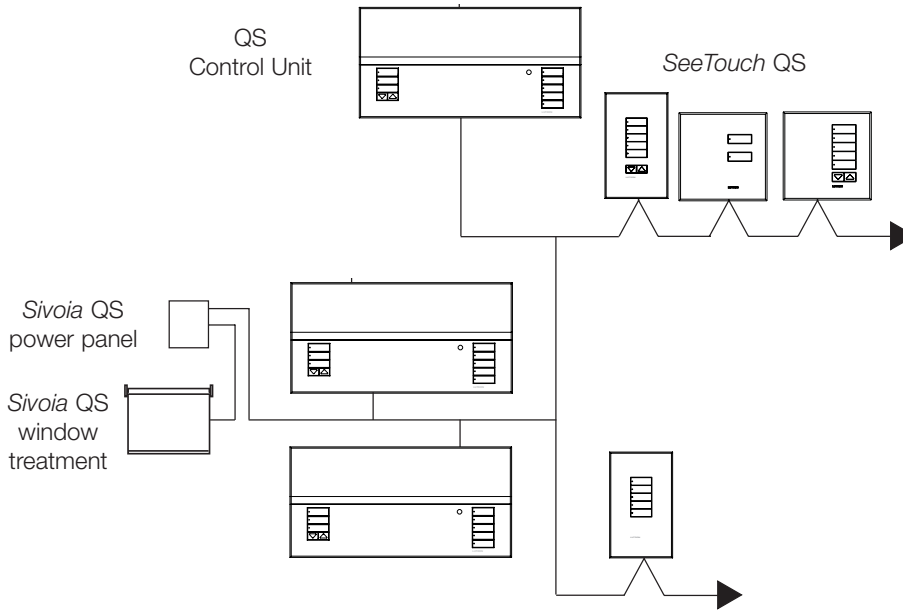

<p><b>Job Name:</b></p> <p><b>Job Number:</b></p>	<p><b>Model Numbers:</b></p>
---	------------------------------